



Type 8035 can be combined with...



**Type 8611**  
Universal controller  
eControl



**Type 8619**  
multiCELL  
transmitter/controller



**Type 8802**  
ELEMENT  
control valve system

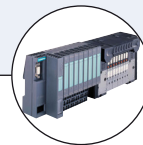

**Type 8644**  
Process actuation  
control system  
AirLINE

## Inline batch controller with paddle wheel

- Up to PN16, size of measurement pipes: DN06 to DN65
- Dosing
- Automatic calibration using Teach-In
- Inputs and outputs can be checked without the need of actual flow
- Total and daily totalized for batch quantity and number of batches, volume or mass totalizers displayed

The 8035 batch controller is specially designed for use with neutral, slightly aggressive, solid free liquids.

The batch controller is made up of a compact sensor-fitting with paddle wheel (S030) and a transmitter (SE35) quickly and easily connected together by a quarter-turn. The Bürkert designed sensor-fitting system ensures simple installation of the devices into all pipes from DN06...DN65.

General technical data	
<b>Compatibility</b>	With Bürkert Inline sensor-fitting S030 (see corresponding datasheet)
<b>Materials</b>	
Housing, cover, lid, nut	PC
Front panel foil / Screws	Polyester / Stainless steel
Cable glands	PA
Wetted parts	
Sensor-fitting, sensor armature	Brass, stainless steel 1.4404/316L, PVC, PP or PVDF
Paddle wheel	PVDF
Axis and bearings / Seal	Ceramics (Al <sub>2</sub> O <sub>3</sub> ) / FKM (EPDM included, but not mounted)
<b>Display</b>	15 × 60 mm, 8-digit LCD, alphanumeric, 15 segments, 9 mm high
<b>Electrical connections</b>	Cable glands M20 × 1.5
<b>Connection cable</b>	Cable with maximum operating temperature greater than 80 °C (90 °C for UL-Recognized version)
External diameter	max. 50 m, shielded, 0.2...1.5 mm <sup>2</sup> wires cross-section 6...12 mm or 4 mm when using a multiway seal
Complete device data (Sensor-fitting S030 + Transmitter SE35)	
<b>Pipe diameter</b>	DN06...DN65
<b>Measuring range</b>	0.3...10 m/s
<b>Fluid temperature with fitting in</b>	
PVC/ PP	0...+50 °C (+32...+122 °F) / 0...+80 °C (+32...+176 °F)
PVDF, brass or stainless steel	-15...+100 °C (+5...+212 °F)
<b>Fluid pressure max.</b>	PN10 (145.1 PSI) (with plastic fitting) - PN16 (232.16 PSI) (with metal fitting - PN40 on request, see S030 datasheet) - see Pressure/Temperature diagram on page 2
<b>Viscosity / Particles rate</b>	300 cSt max. / 1 % max. (size: 0.5 mm max.)
<b>Measurement deviation<sup>1)</sup></b>	
Teach-In	±1 % of the measured value <sup>2)</sup> (at Teach-In flow rate value)
Standard K-factor	±2.5 % of the measured value <sup>2)</sup>
<b>Linearity</b>	±0.5 % of F.S.* <sup>2)</sup>
<b>Repeatability</b>	±0.4 % of the measured value <sup>2)</sup>

\* F.S. = Full scale (10 m/s)

<sup>1)</sup> = "measurement bias" as defined in the standard JCGM 200:2012

<sup>2)</sup> Under reference conditions i.e. measuring fluid = water, ambient and water temperature = 20 °C (68 °F), while maintaining the minimum inlet and outlet distances and the appropriate internal diameter of the pipes.

# 8035 / SE35

## Inline

bürkert

! If the device is mounted in a humid environment or outside, then the maximum voltage allowed is **35 V DC** instead of 36 V DC.

Electrical data	
<b>Power supply (V+)</b>	12...36 V DC (max tolerance: -5% or +10% at 12 V DC; ±10% at 36 V DC), filtered and regulated, SELV (safety extra low voltage) circuit with a non dangerous energy level or 115/230 V AC 50/60 Hz (see technical specifications 115/230 V AC)
<b>Characteristics of the power source (not provided) of UL-Recognized devices</b>	Limited power source (according to § 9.4 of the UL 61010-1 standard) or, Class 2 type power source (according to the 1310/1585 and 60950-1 standards)
<b>Reversed polarity of DC</b>	protected
<b>Current consumption with sensor</b> Version with relay	Without consumption of digital input and pulse output ≤ 100 mA (at 12 V DC); ≤ 50 mA (at 36 V DC); ≤ 55 mA (115/230 V AC)
Version without relays	≤ 70 mA (at 12 V DC); ≤ 35 mA (at 36 V DC); ≤ 40 mA (115/230 V AC)
<b>Inputs DI (1 to 4)</b>	Switching threshold Von: 5...36 V DC; Switching threshold Voff max: 2 V DC; Input impedance: 9.4 KOhms; Galvanic insulation, protected against polarity reversals and voltage spike
<b>Outputs</b> Transistors (DO1 and DO4)	NPN or PNP (wiring dependent), potential free; function: pulse output (by default for DO1), batch state (by default for DO4), configurable and parameterizable 0.6...2200 Hz, 5...36 V DC, 100 mA max., line drop 2.7 V DC at 100 mA duty cycle: ■ > 0.45 if 0.6 < frequency < 300 Hz ■ > 0.4 if 300 < frequency < 1500 Hz ■ < 0.4 if 1500 < frequency < 2200 Hz Galvanic insulation, protected against overvoltage, polarity reversals and short-circuits
Relays (DO2 and DO3)	2 relays (normally open), parameterizable (by default: DO2 always configured to control the valve, parameterized of 100% of the batch quantity and DO3 configured as alarm), 230 V AC/3 A or 40 V DC/3 A (resistive load), max. cutting power of 750 VA (resistive load)

### Technical specifications 115/230 V AC

<b>Voltage supply available inside the device</b>	27 V DC regulated, max. current: 125 mA integrated protection: fuse 125 mA temporised power: 3 VA
---	---

### Environment

<b>Ambient temperature</b> (operation and storage)	-10...+60 °C (+14...+140 °F) (12...36 V DC version) -10...+50 °C (+14...+122 °F) (115/230 V AC version)
<b>Relative humidity</b>	≤ 80 %, without condensation
<b>High above sea level</b>	Max. 2000 m

### Standards, directives and certifications

<b>Protection class</b> (according to EN 60529)	IP65 with device wired, cover and lid screwed tight and cable glands mounted and tightened or with blanking plug if not used.
--	---

<b>Standards and directives CE</b>	The applied standards, which verify conformity with the EU Directives, can be found on the EU Type Examination Certificate and/or the EU Declaration of conformity (if applicable) Complying with article 4, §1 of 2014/68/EU directive*
Pressure	

<b>Certification</b> UL-Recognized for US and Canada 	UL 61010-1 + CAN/CSA-C22.2 No. 61010-1
---	--

### Specific technical data of UL-Recognized products for US and Canada

<b>Relay output</b>	30 V AC and 42 V peak max./3 A or 60 V DC max./1 A
<b>Ambient temperature</b>	0...+40 °C (+32...+104 °F)
<b>Relative humidity</b>	max. 80 %, without condensation
<b>Intended for an inner pollution</b>	Pollution degree 2 according to EN 61010-1
<b>Installation category</b>	Category I according to UL 61010-1 – indoor use

### Pressure/temperature chart

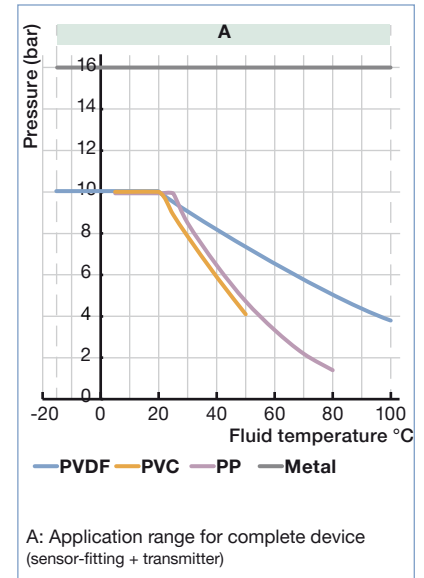

\* For the 2014/68/EU pressure directive, the device can only be used under the following conditions (depends on max. pressure, pipe diameter and fluid).

Type of Fluid	Conditions
<b>Fluid group 1, article 4, §1.c.i</b>	DN ≤ 25
<b>Fluid group 2, article 4, §1.c.i</b>	DN ≤ 32 or PN*DN ≤ 1000
<b>Fluid group 1, article 4, §1.c.ii</b>	DN ≤ 25 or PN*DN ≤ 2000
<b>Fluid group 2, article 4, §1.c.ii</b>	DN ≤ 200 or PN ≤ 10 or PN*DN ≤ 5000

## Operation and display

When mounted in a pipe in series with one or two valves, the 8035 batch controller makes it possible to carry out a dosing of one or several quantities of liquids. The unit controls the opening of the valves and measures the quantity of the fluid which flows. The unit also closes the valves when the preset quantity has been delivered.

The electronic component needs a voltage supply of 12...36 V DC or 115/230 V AC.

The device is equipped with 4 digital inputs (DI1 up to DI4), 2 transistor outputs (DO1 configured as a pulse output and DO4 configured as state output, by default), 2 relay outputs (DO2 always configured to control the valve and by default parameterize of 100 % of the batch quantity and DO3 configured as alarm output by default), two volume or mass totalizers and two batch totalizers.

The second relay output can be used to activate another valve, to initiate alarms or to generate warnings.

The following dosing modes are possible:

- **Locally started dosing of free quantity:**  
the user enters the quantity to be filled and starts the dosing from the keypad.
- **Locally started dosing of preset quantity:**  
the user selects a quantity which has been preset and starts the dosing from the keypad.
- **Locally started dosing of free/preset quantity**  
the user enters the quantity to be filled or selects a quantity which has been preset and starts the dosing from the keypad.
- **Dosing controlled by a PLC unit**  
the user selects a quantity which has been preset and starts the dosing using binary inputs.
- **Locally/remote selection of preset quantity and dosing controlled by a PLC unit:**  
the user selects a quantity which has been preset from the keypad or using binary inputs and starts the dosing using binary inputs.
- **Automatic dosing controlled by variation of pulse duration:**  
the quantity of the dosing is directly proportional to the duration of a pulse.
- **Remote dosing determined by Teach-In:**  
Teach-In of the dosing quantity using binary inputs.
- **Local dosing determined by Teach-In:**  
Teach-In of the dosing quantity from the keypads.

The device is calibrated by means of the K-factor which is either entered or determined via the Teach-In functions.

User adjustments, such as measuring range, engineering units, pulse output, etc. are carried out via the device operators interface.

The operation is specified according to five levels:

Indication in operating mode/ display	Parameter definition	Test	Information	History
<ul style="list-style-type: none"> <li>• dosing amount</li> <li>• dosing mode</li> <li>• main quantity totalizer</li> <li>• daily quantity totalizer with reset function</li> <li>• main batch totalizer</li> <li>• daily batch totalizer with reset function</li> </ul>	<ul style="list-style-type: none"> <li>• language</li> <li>• engineering units</li> <li>• K-factor/Teach-In function</li> <li>• selection of dosing mode</li> <li>• over run correction</li> <li>• alarm</li> <li>• outputs configuration</li> <li>• reset both quantity/batch totalizers (main and daily)</li> <li>• Brightness of the display (backlight)</li> </ul>	<ul style="list-style-type: none"> <li>• input test</li> <li>• output test</li> <li>• frequency test</li> <li>• warning and fault messages generating</li> <li>• configuration mode</li> </ul>	<ul style="list-style-type: none"> <li>• Display of error, alarm and/or warning messages</li> </ul>	<ul style="list-style-type: none"> <li>• Display of the 10 latest batches</li> </ul>

Description of the navigation keys and the status LEDs

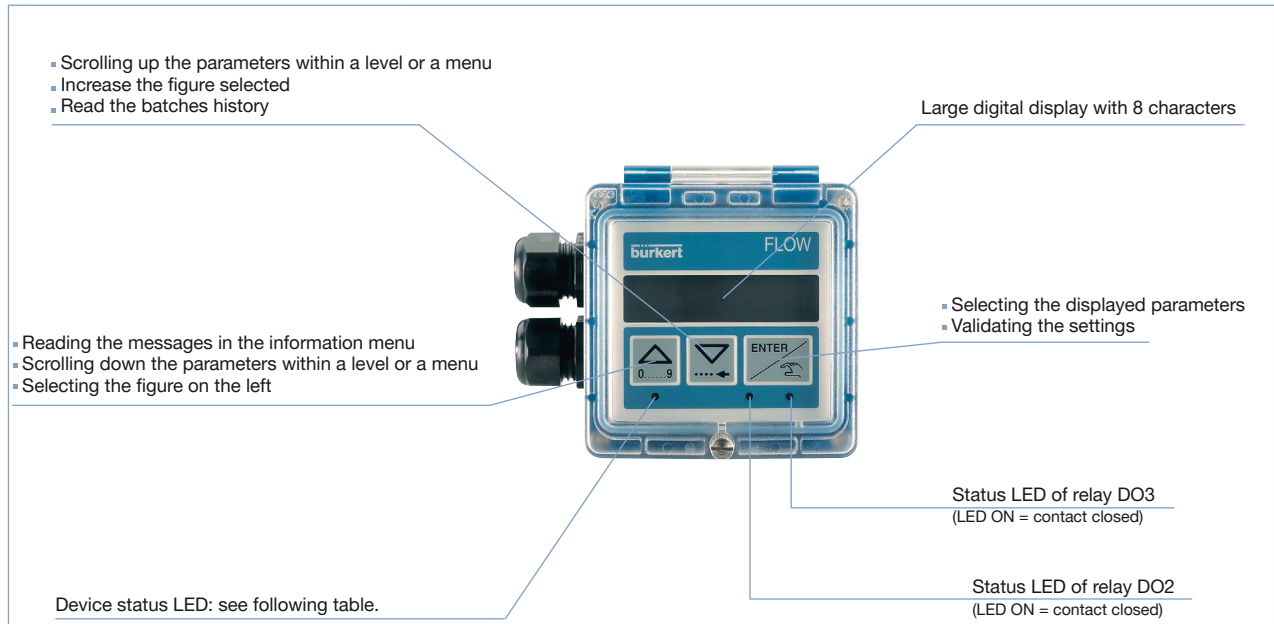

Device status LED	Status of the device
<b>Green</b>	The device operates correctly.
<b>Orange</b>	A dosing related alarm and/or a warning messages is generated in the information menu.
<b>Red</b>	A fault message is generated in the information menu.
<b>Blinking, whatever the colour</b>	<ul style="list-style-type: none"> <li><b>Slow blinking:</b> The dosing is interrupted.</li> <li><b>Fast blinking:</b> - during a dosing: a dosing related alarm is generated.</li> <li>- dosing not active: the information menu has been remote-consulted or a check for the correct behaviour of the inputs/outputs is running.</li> </ul>

## Design and principle of operation

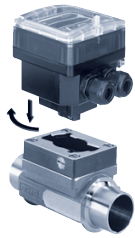

The electronic housing of the 8035 integrates the electronic board with display, setting parameter keys and also a transducer (Hall). The paddle wheel is mounted in the sensor-fitting. The output signals are provided via two cable glands. Bürkert designed sensor-fitting ensures simple installation of the Bürkert bath controller into pipes from DN06...DN65.

When liquid flows through the pipe, the paddle wheel with 4 inserted magnets is set in rotation, producing a measuring signal in the sensor (Hall sensor). The frequency modulated induced voltage is proportional to the flow velocity of the fluid.

A conversion coefficient (K-factor, available in the instruction manual of the S030 sensor-fitting), specific to each pipe (size and material) enables the conversion of this frequency into flow rate.

The electronic component converts the measured signal and displays the actual value of the volume or mass.

## Installation

The SE35 transmitter can easily be installed into any Bürkert Inline sensor-fitting system (S030) by means of a quarter-turn.

**Minimum straight upstream and downstream distances must be observed.** According to the pipe's design, necessary distances can be bigger or use a flow conditioner to obtain the best accuracy. For more information, please refer to EN ISO 5167-1.

EN ISO 5167-1 prescribes the straight inlet and outlet distances that must be complied with when installing fittings in pipe lines in order to achieve calm flow conditions. The most important layouts that could lead to turbulence in the flow are shown below, together with the associated prescribed minimum inlet and outlet distances.

These ensure calm, problem-free measurement conditions at the measurement point.

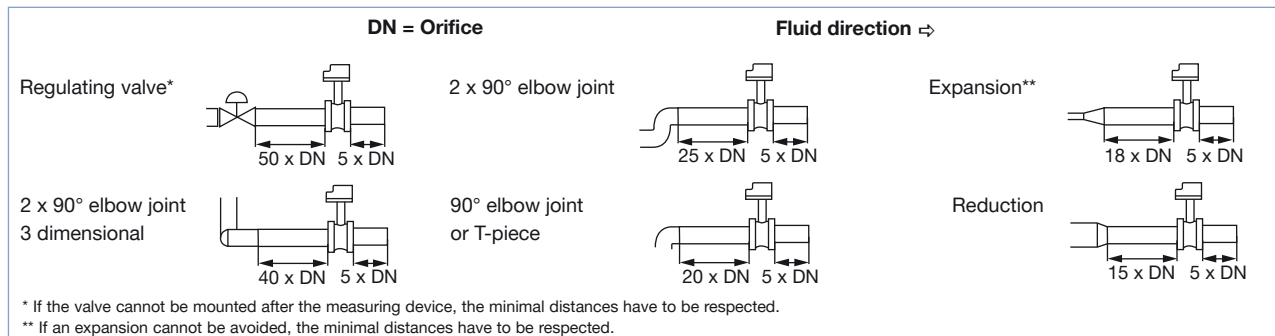

The device can be installed into either horizontal or vertical pipes.

Important criteria for this are; ensure that the measurement pipe is fully filled and that the measurement pipe is air bubble free.

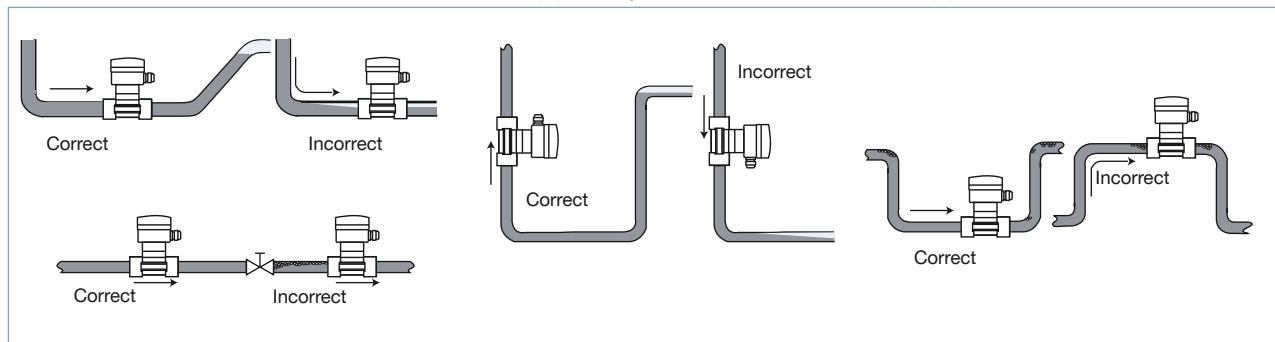

Pressure and temperature ratings must be respected according to the selected fitting material.

The suitable pipe size is selected using the diagram Flow/Velocity/DN.

The batch controller is not designed for gas and steam flow measurement.

Diagram Flow/Velocity/DN

Example:

- Specification of nominal flow: 10 m<sup>3</sup>/h
- Ideal flow velocity: 2...3 m/s

For these specifications, the diagram indicates a pipe size of DN40 (or DN50 for (\*) mentioned fittings)

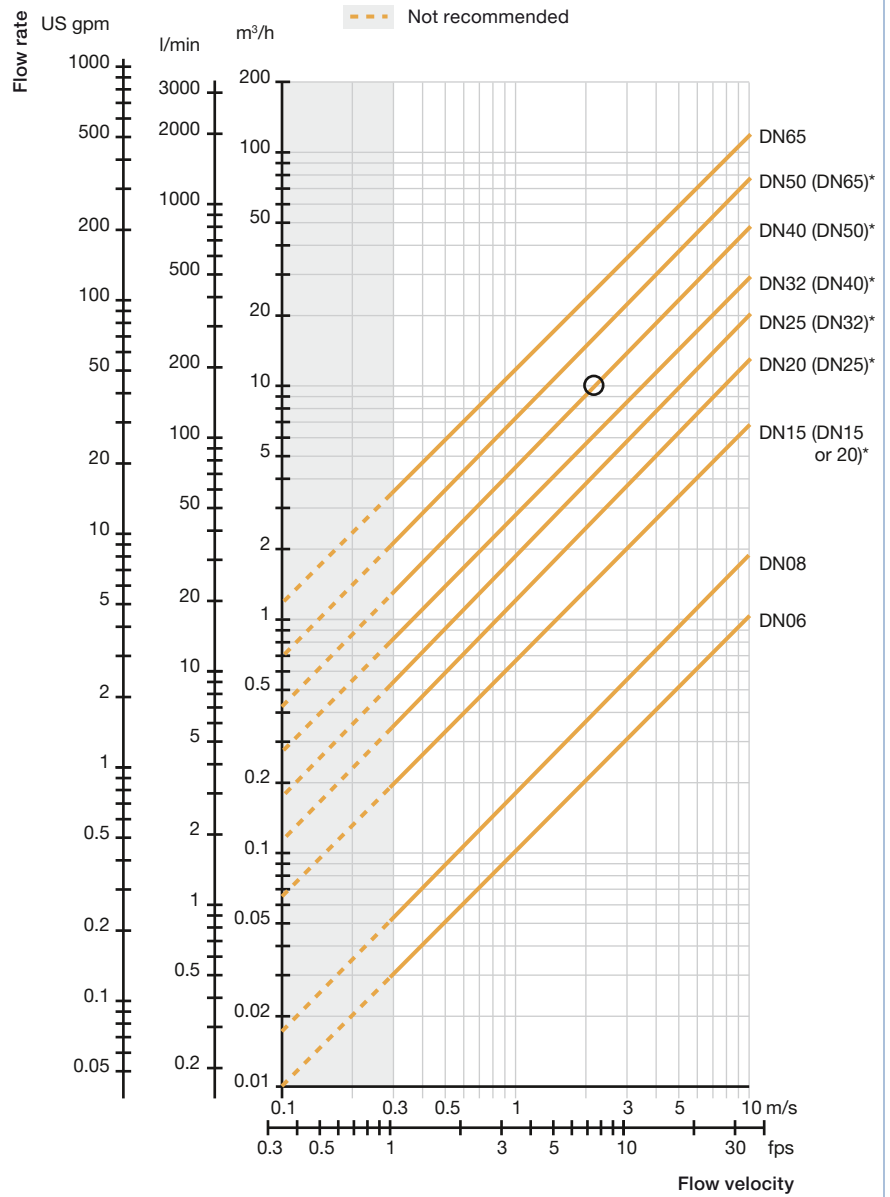

\* for following fittings with:

- external threads acc. to SMS 1145
- weld ends acc. to SMS 3008, BS4825-1/ASME BPE/DIN 11866 series C or DIN 11850 series 2/DIN 11866 series A/DIN EN 10357 series A
- Clamp acc. to SMS 3017, BS 4825-3/ASME BPE or DIN 32676 series A

Dimensions [mm]

SE35 Transmitter

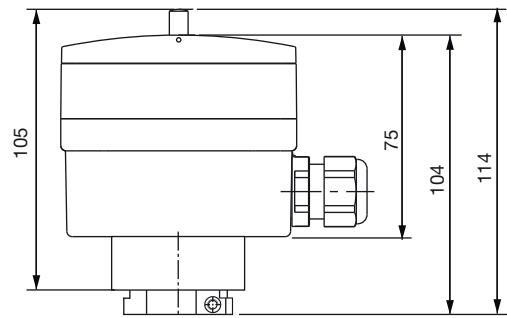
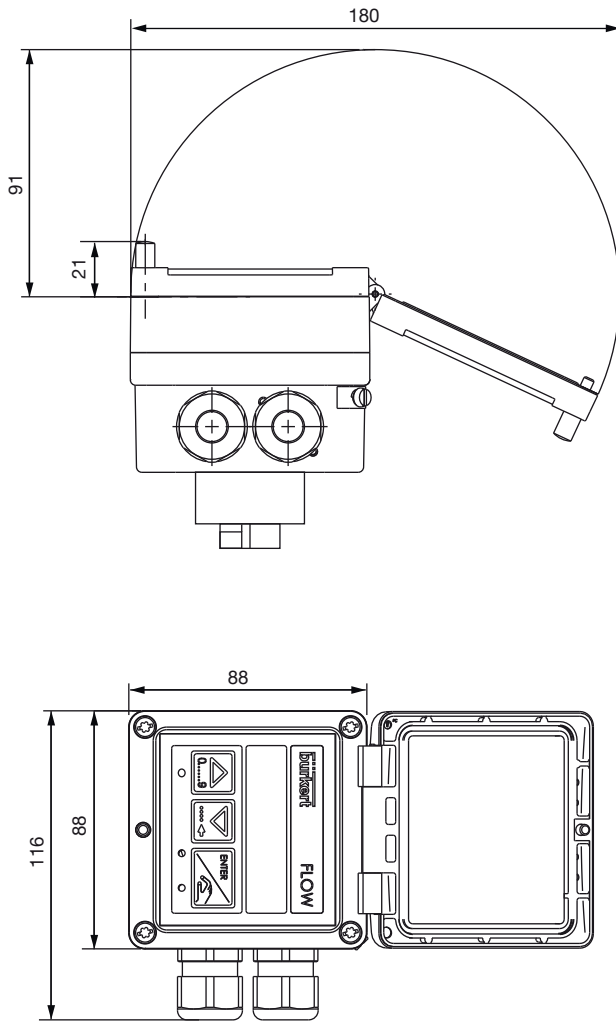

Batch controller (SE35 transmitter + sensor-fitting S030)

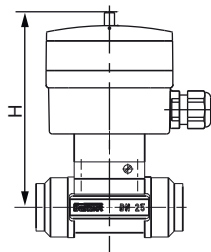

DN	H
06	134
08	134
15	139
20	137
25	137
32	140
40	144
50	151
65	151

## Ordering information and chart for batch controller

A complete 8035 batch controller with integrated paddle wheel sensor consists of an SE35 Inline transmitter and a Bürkert S030 Inline sensor-fitting.

The following information is necessary for the selection of a complete device:

- **Article no.** of the desired compact **SE35** transmitter (see ordering chart below)
- **Article no.** of the selected **S030** Inline fitting (see separate datasheet)

More info.

→ You have to order the two components separately.

When you click on the orange box "More info.," you will come to our website for the resp. product where you can download the datasheet.

- All these versions have as minimum:
- 2 transistor outputs (DO1 and DO4)
  - 2 relay outputs (DO2 and DO3)
  - 4 digital inputs (DI1...DI4)
  - 2 volume or mass totalizers
  - 2 batch totalizers

Specifications	Voltage supply	Sensor version	Certification	Electrical connection	Article no.
Transmitter - batch controller	12...36 V DC	Hall	-	2 cable glands	443360
		Hall	UL-Recognized for US and Canada	2 cable glands	564398
	115/230 V AC	Hall	-	2 cable glands	423926

## Ordering chart - accessories (has to be ordered separately)

Specifications	Article no.
Set with 2 cable glands M20 x 1.5 + 2 neoprene flat seals for cable gland or plug + 2 screw plugs M20 x 1.5 + 2 multiway seals 2 x 6 mm	449755
Set with 2 reductions M20 x 1.5 /NPT 1/2" + 2 neoprene flat seals for cable gland or plug + 2 screw plugs M20 x 1.5	551782
Set with 1 stopper for unused cable gland M20 x 1.5 + 1 multiway seal 2 x 6 mm for cable gland + 1 black EPDM seal for the sensor + 1 mounting instruction sheet	551775
Set with 8 FLOW foils	553191

## Interconnection possibilities with other Bürkert flowmeters

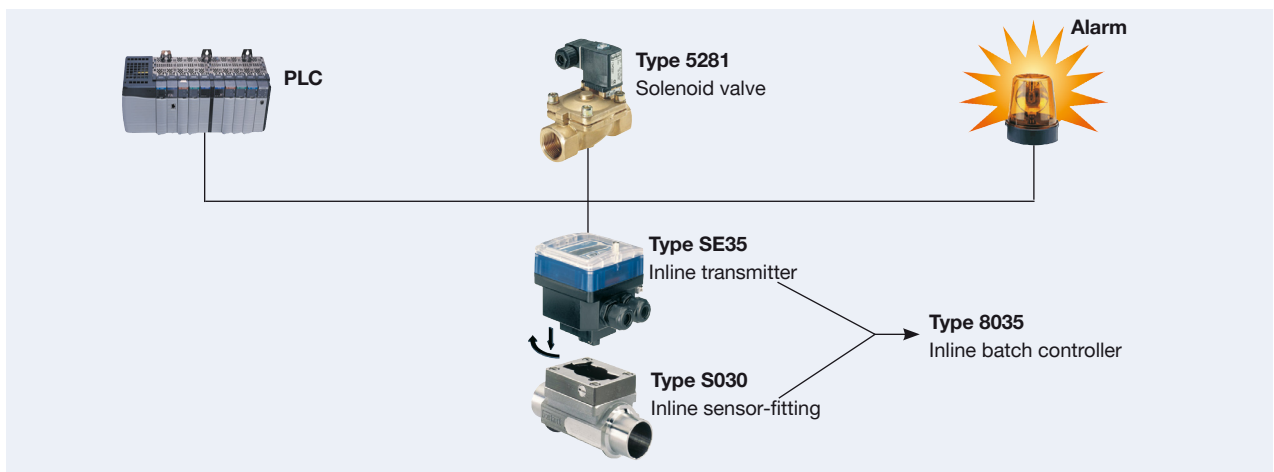

To find your nearest Bürkert facility, click on the orange box →

[www.burkert.com](http://www.burkert.com)

In case of special application conditions, please consult for advice.

Subject to alteration.  
© Christian Bürkert GmbH & Co. KG

1804/14\_EU-en\_00891787